

鋼材リスト

C	H-150×150×7×10
G1	I-200×150×9
B1	[-9×75×150
B3	L-6×65×65
B5	□-100×100×3.2
B6	C-100×50×20×2.3
B7	[-5×50×100
P1	SGP32A
P2	SGP20A
P3	SGP25A
P4	φ19 丸棒
床板	t 3. 2 編鋼板

※塗装仕上げ

製作数：4組

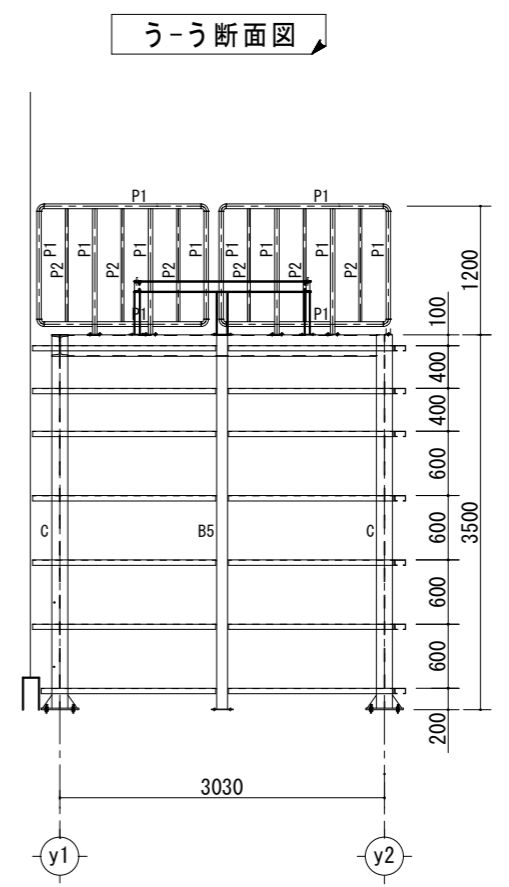
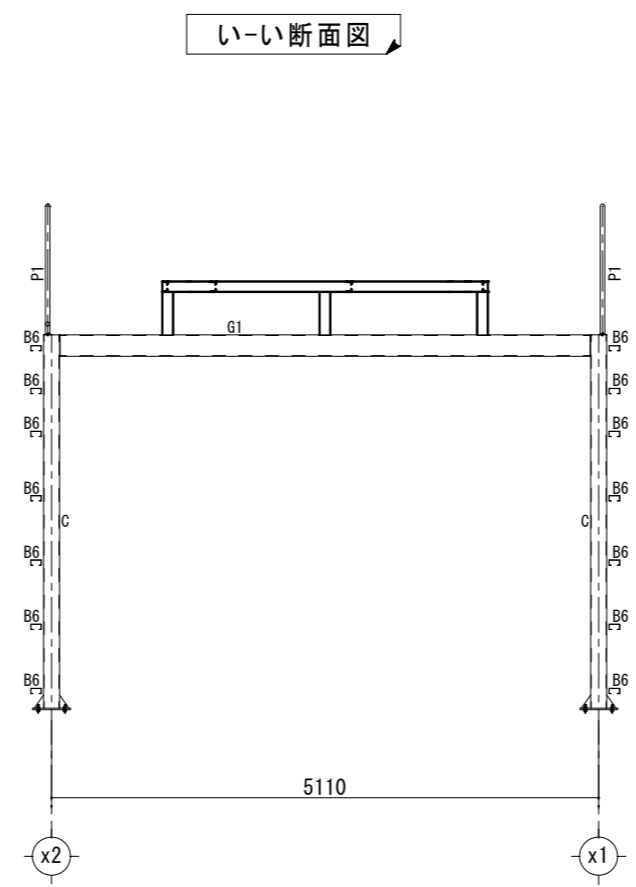
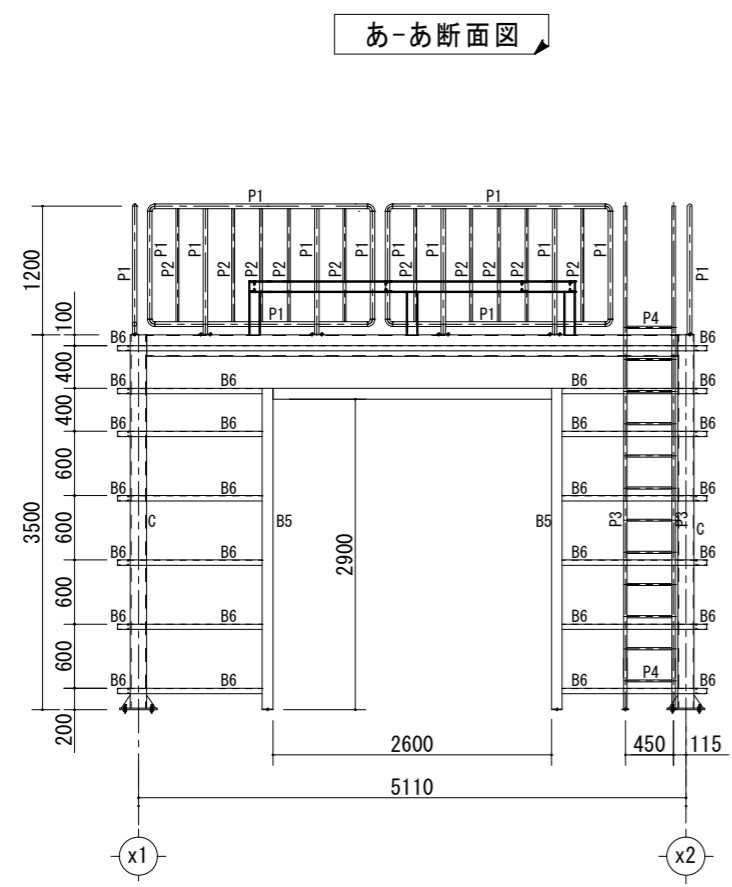

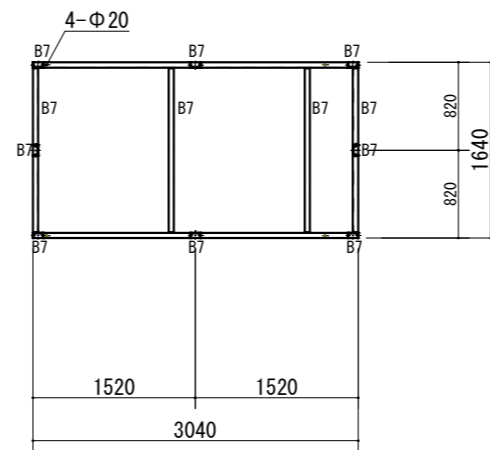
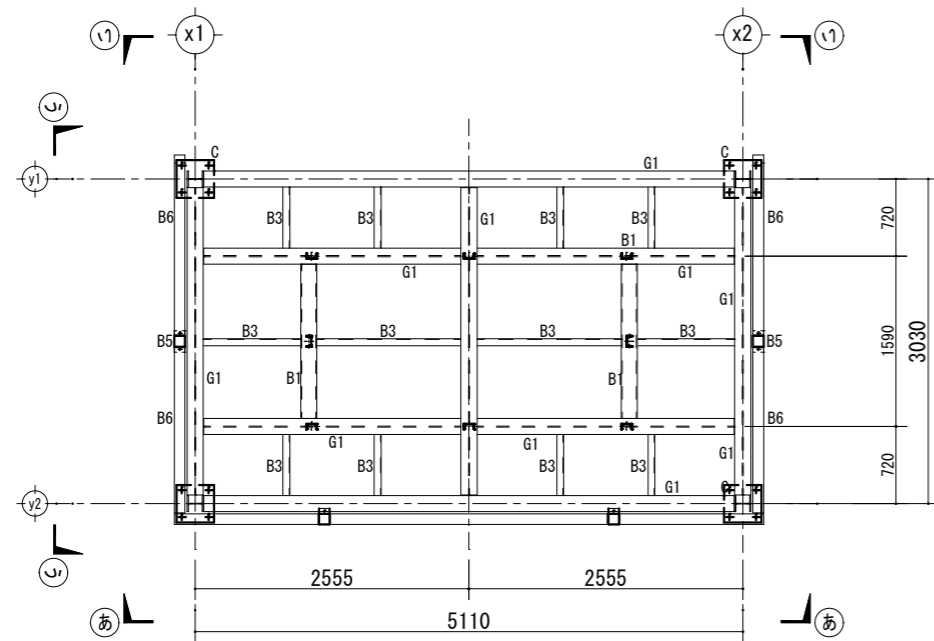

鋼材リスト

C	H-150×150×7×10
G1	I-200×150×9
B1	[-9×75×150
B3	L -6×65×65
B5	□ -100×100×3.2
B6	C-100×50×20×2.3
B7	[-5×50×100
P1	SGP32A
P2	SGP20A
P3	SGP25A
P4	φ19 丸棒
床板	t 3.2 縞鋼板

※塗装仕上げ

製作数：4組

運転重量：2500kg

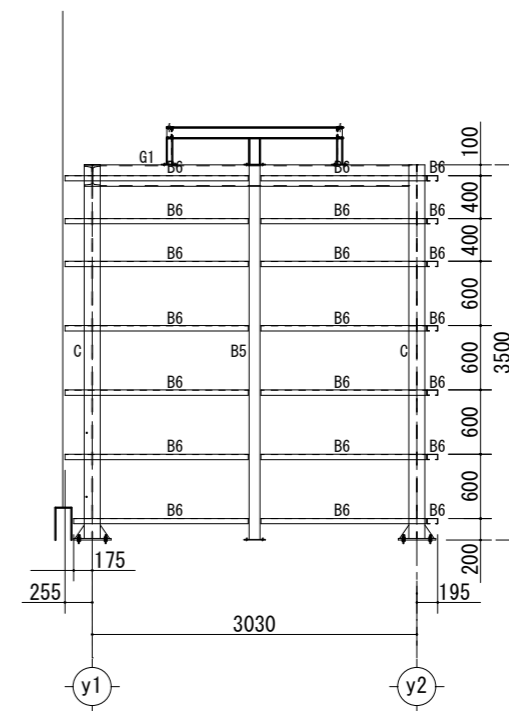
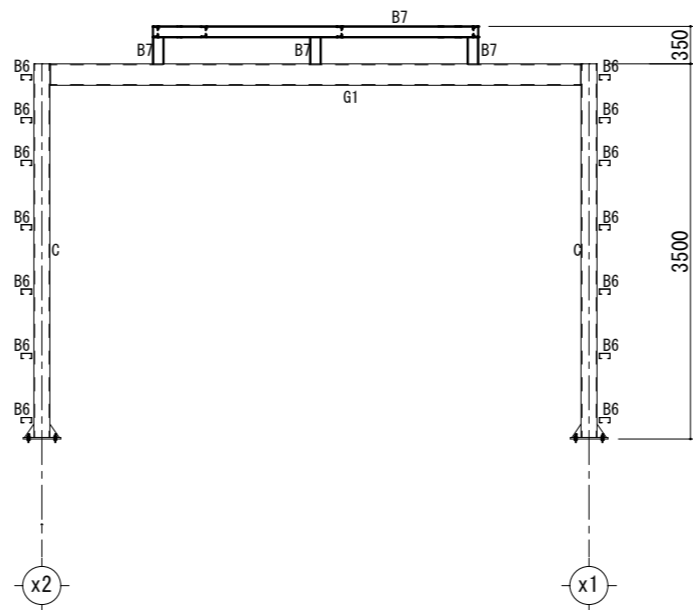
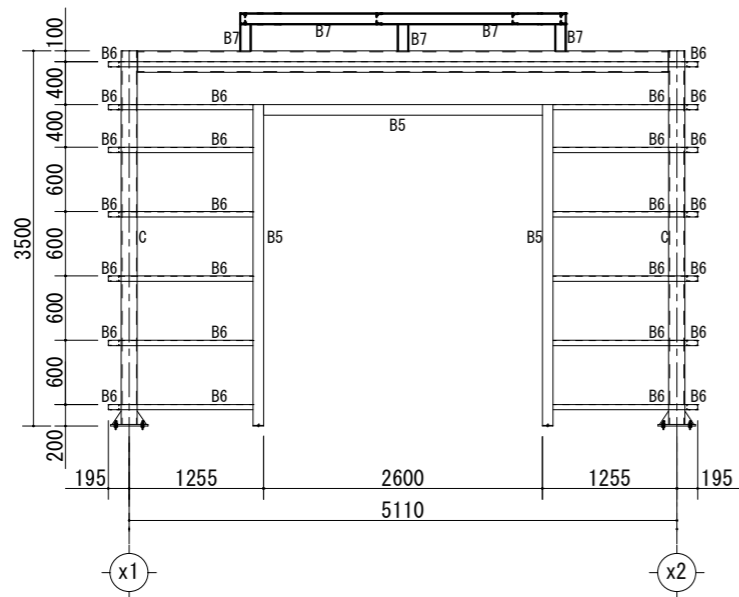

TITLE	NAME	SCALE	 株式会社 平設計 <small>一級建築士事務所登録03-578号 一級建築士登録93620号 足立 收平</small>	DATE	CHECK	DRAWING	NO.
共同利用冷凍冷蔵施設整備建設工事	冷蔵庫風除室鉄骨図 (2)	1/50		R06.03			RS - 02 /
※ A 2 → A 3 へ縮小 (70.7%)							